

SIEMENS



Process Instrumentation and Analytics

Reliable processes thanks to perfect integration of all components

Food & Beverage



Answers for industry.



Table of Contents

| | |
|--|----|
| Your challenge is our passion | 03 |
| Your partner for best quality | 04 |
|  Sugar | 06 |
| Dairy | 08 |
| Brewing | 10 |
| Soft drinks | 12 |
|  Selected technologies | 14 |
| Level, flow, pressure, temperature, valve positioning, weighing and dosing, liquid analytics | |
|  Process Instrumentation and Analytics product range | 24 |
|  Totally Integrated Automation | 28 |
| Industrial Identification | 30 |
| Services and support | 31 |



Your challenge is our passion

Changing demographics, new consumer tastes, quality expectations, evolving regulation and price constraints pressure on profit margins. The food and beverage sector faces a range of challenges. The demands of big retailers are increasing. Concerns about food safety are always present. The need for faster and more flexible supply lines is intensifying. Product tracking and tracing are becoming increasingly important.

In this environment, competitive advantage is the number one priority: minimizing the total cost of ownership while maintaining flexible offers. With the right automation in place, companies can turn competition and pressure to their advantage.

Gaining control with measurements is right at the heart of food and beverage manufacturing. It is key to unlocking value, enhancing quality, leveraging flexibility, boosting profitability and maintaining reliability. Whether it is the technology to break through bottlenecks, improve quality or to provide early warning of failure, we have the knowledge of industry processes and the applications to keep customers on the road to success.

Siemens delivers world-class capabilities to meet the challenges faced by the food and beverage industry. Siemens is able to address the full range of process instrumentation and analytics requirements. Our global reach and extensive product portfolio enables us to meet your development needs and requirements.

When you partner with Siemens, you have the right ingredients for success:

- A perfectly coordinated and harmonized portfolio of products and solutions for every process step in the value chain
- A single concept for seamless integration of the entire company to master productivity, quality and supply challenges
- Fewer different components – simplifying the inventory of spare parts and ensuring highly efficient maintenance
- The assurance of a world-class brand delivering leading-edge automation technology
- People who understand your industry needs and can configure solutions to match your operating conditions

Your partner for efficient processes

Food is the energy of life. That is why trust and confidence play such an important part in the food and beverage market. Yet the issue of trust and confidence is not confined to questions about quality and safety. Product availability is also crucial in winning the battle for shelf space.









Whatever your sector of the market is – whether you are a food and beverage company or an original equipment manufacturer (OEM) – you can be assured that Siemens quality and results will help you meet your business and customer goals.

The Siemens approach:

- An emphasis on user-friendly products – for safer, faultless operation
- A high degree of product safety – through maximum process transparency
- Optimal resource efficiency – through innovative platform concepts
- More flexibility – for faster and safer production changeover
- Increased productivity – with optimal solutions for the operating phase

Customer benefits:

- Fast commissioning, short ramp-up times
- Low total cost of ownership
- Continuous process through innovative service and support concepts
- Traceability to ensure manufacturing quality through completely integrated production
- Maximum compatibility and innovation providing you with confidence in the future

- Level 
- Flow 
- Pressure 
- Temperature 
- Positioning 
- Weighing 
- Liquid analytics 
- Identification 



Sugar

A wide range of competitive and manufacturing challenges face the sugar industry. Demand for sugar is steadily increasing but also shifting from domestic use to its application in terms of raw materials in processed food and beverages. This has increased the importance of supply chain logistics. Higher energy, water and utility costs have also added pressure to the cost base, intensifying the need for manufacturing efficiency.

Companies need to be able to manage high energy and utility demands. Buildings automation and manufacturing controls are becoming more important. Continuous 24/7 plant operation is critical for sugar plants with zero scheduled downtime. The size and colour of the microcrystal in

the sugar solution are vital qualitative factors. Successful sugar manufacturing demands a high level of automation and precise control over process parameters, saving time and increasing output.



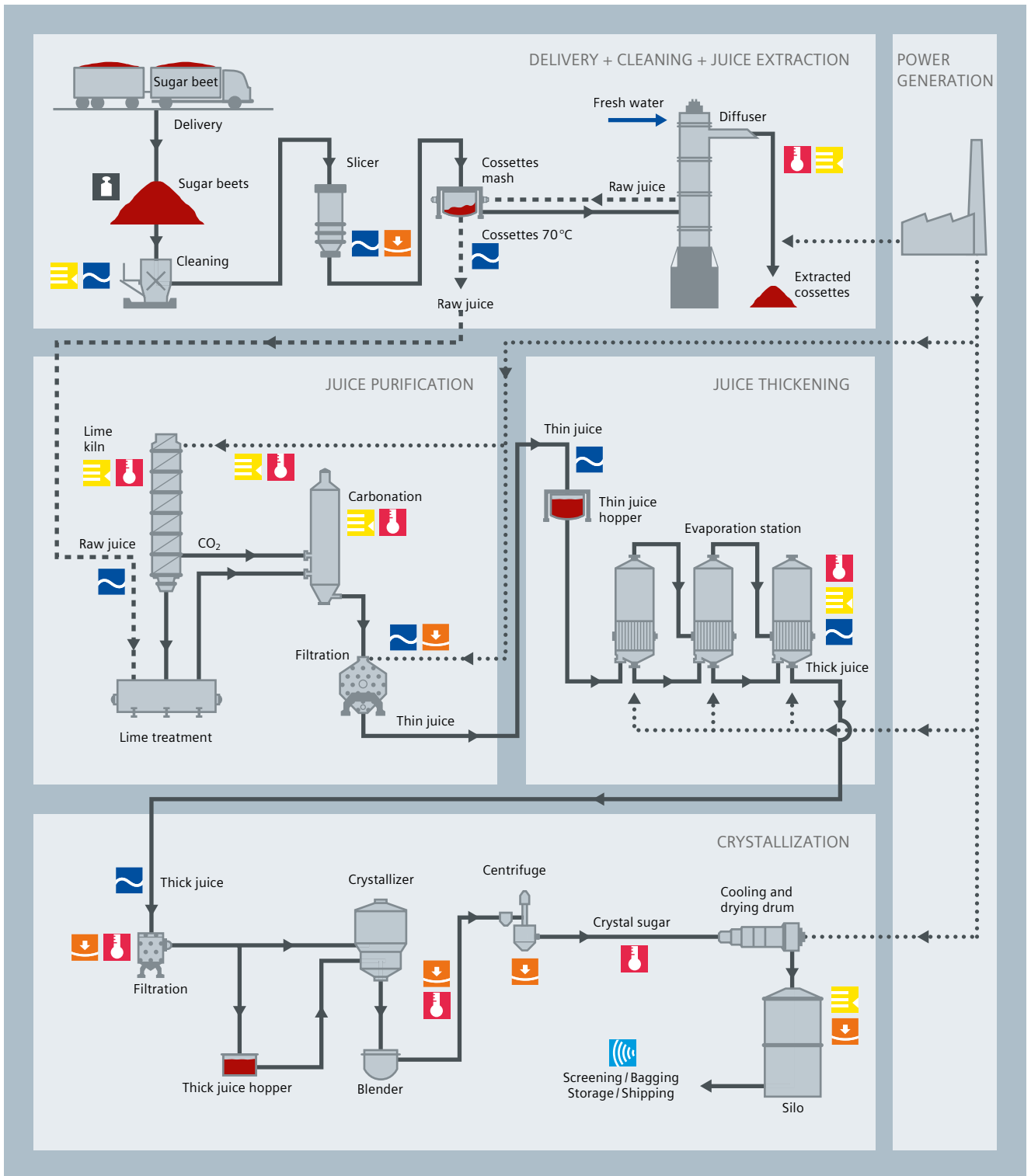

Dairy

The importance of dairy products in daily nutritional requirements means that continuous availability and high quality are paramount considerations for manufacturers. Hygiene is also critical, given that milk is an ideal culture in which micro-organisms can grow. Dairy production is subject to close government regulation and consumer scrutiny. Measurement and control of temperature and of fat and protein content are vitally important to the dairy manufacturing process.

Milk, cheese and fermented products, such as yoghurt, all require precise production control parameters. The cultures used in cheese and fermented products make temperature control exceedingly important. Pure cultures must be produced very carefully according to hygienic principles. A poor or mismatched culture can lead to substantial product deficits. Tight control over storage times for cheese is essential. Cheese can last from several weeks to many months depending on temperature and humidity, both of which must be monitored precisely and adapted to each brand.

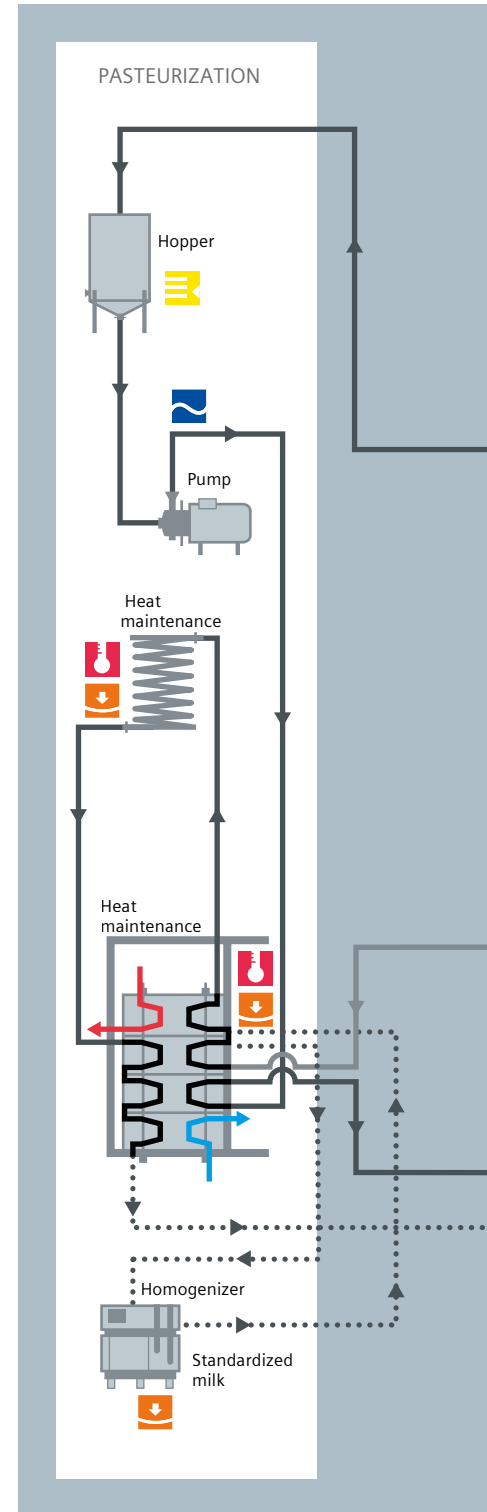

Level

Flow

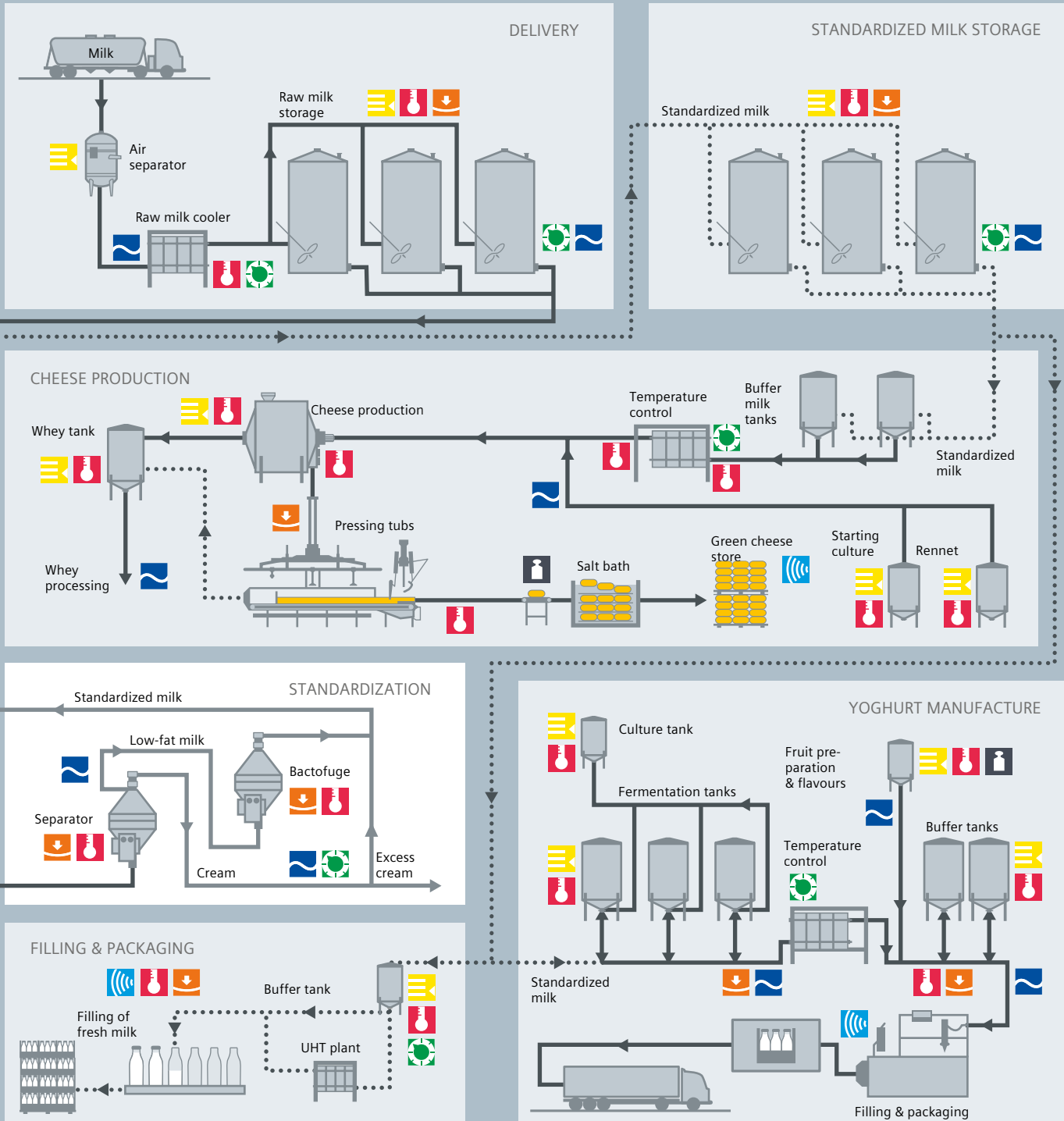

Pressure  Temperature  Valve positioning  Identification  Weighing 

Brewing

Brewers operate in intensely competitive product markets. Reputation, quality, customer loyalty and trust are everything. Price is king in key sectors of the marketplace. Companies operate in a highly dynamic customer-driven environment. In addition, seasonality heightens the importance of being able to utilize the brewery in a fast and flexible way but, always, with a focus on quality.

Whatever the marketplace, the ability to arrive at a finished, consistent beer quality is paramount. From milling and mashing, boiling and fermentation, filtration and conditioning, right through to the keg or the bottle, accurate measurement in terms of volume, weight, temperature

and turbidity is vital to the brewing process. Breweries also require access to an integrated view of the production and supply chain, enabling them to incorporate manufacturing controls and automation into their overall management systems.



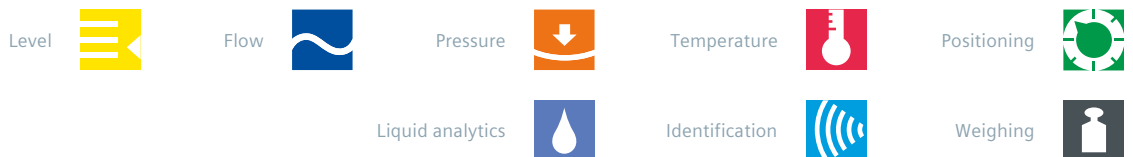
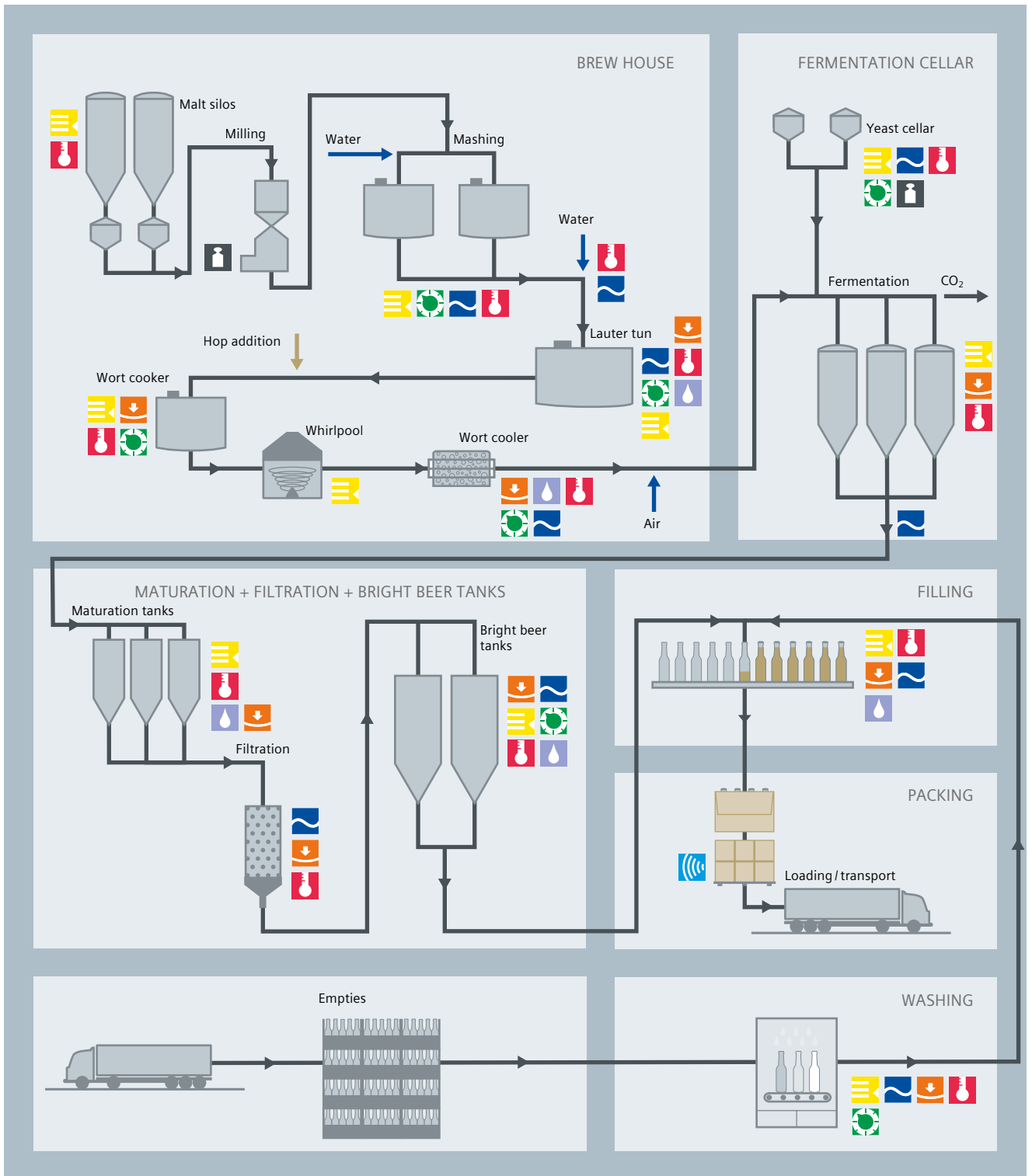

Soft drinks

Whether sports or energy beverages, the more traditional and well-established carbonated drinks or the new tea and coffee-based cold beverages, the soft drinks market is experiencing significant growth. Product innovation and diversification are key drivers in this expansion, putting more pressure on the use of production plants.

In common with other sectors of the food and beverage market, hygiene is critical. Most soft drinks are very susceptible to microbiological spoilage due to their high sugar content. Water quality must be consistent with the

need to prevent the interaction of elements in the water with flavourings. Accurate flow measurement and precise dosing of the ingredients are vital to a consistent and high-end quality product.



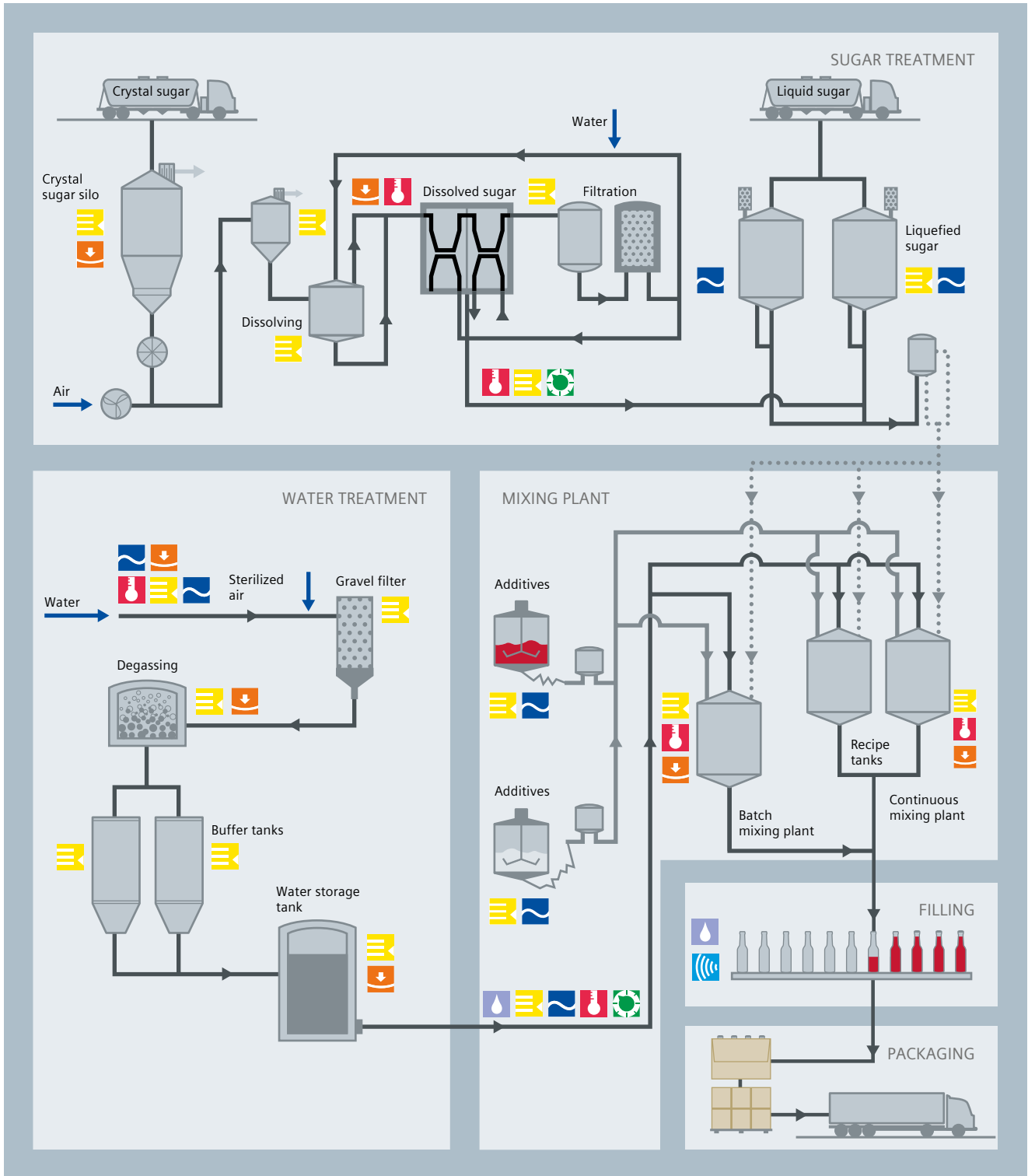

Level

The quality of food and beverage products relies on precise and accurate level measurements that ensure reliability in process controls, overflow prevention and protection against dry-running pumps. Such criteria are also used to balance and check stocks of raw materials, semi-finished products and finished goods. Inventory management must be implemented with the utmost precision to allow for the adequate demarcation and retracing of individual batches. The entire production planning process and supporting logistics depend upon ready availability of the correct stock.

Ice cream

Glucose is a central ingredient in ice cream production. It has a very high specific gravity and must be maintained at a temperature of 50 °C (122 °F) to ensure consistent flow. The supply of glucose must be ready to meet typical 16-hour and five-week plant production schedules. Effective storage and inventory control is therefore a priority. Ultrasonic technology provides for an ideal solution because it is non-invasive, and thus non-contaminating.

Echomax transducer with SITRANS LUT400 controller

- An ultrasonic level measurement system. The SITRANS LUT400 controller processes the signals from the Echomax sensor, providing a continuous readout of data relating to the tank level
- High-performance instrumentation provides continuous level measurement for virtually any short or medium range application up to 60 m (200 ft)
- Built-in Sonic Intelligence prevents interference from agitators and other obstructions commonly found in tanks
- Easy installation, set-up and operability

Grain silos

Beer is made from malt, water, hops and yeast. The key to efficiency and quality in beer production lies in the quality, purity and continuous availability of these raw materials. Malt is produced in malt houses, whence it is delivered to the breweries and stored in silos. Dust can accumulate once the barley or other grains are transferred to the silo. The problems this creates for level measurement can be compounded by the shape and design of the grain silo.

SITRANS radar technology

- SITRANS LR560 78 GHz radar transmitter allows for measurement through dust within enclosed silos
- An exceptionally narrow 4-degree beam angle can cope with complicated silo geometry
- Sealed lens cavity is highly resistant to dust build-up

SITRANS ultrasonic technology

- SITRANS LU10 is a highly cost-effective ultrasonic solution with up to ten sensors on one transmitter
- The high-frequency, non-contact ultrasonic transducer is free of additional electronics and is fully potted to provide long-term reliability
- Process intelligence and Auto False Echo Suppression is standard, delivering superior performance with a high degree of accuracy





Raw milk tank

Raw milk delivery and quality-controlled handling is significant for every dairy. Raw milk is delivered by tanker, so the milk has to be stored to guarantee continuous running of the plant. Accurate level measurement is crucial in ensuring proper processing and the prevention of over-spill. The filling process creates turbulence and foam. The shape of the tank, the use of agitators and the presence of Clean-In-Place (CIP) equipment makes measurement difficult. Earlier measurement technologies were unreliable and tended to break down completely during cleaning cycles that made use of caustic soda and nitric acid at very high temperatures.

Echomax XCT-8 transducer with a SITRANS LUT400 controller

- This combination provides accurate and reliable tank measurement
- The transducer has a PTFE-coated sensor to resist build-up and withstand the clean-in-place process
- The controller is connected to the main PLC using the HART protocol to display readings on the SIMATIC PCS 7 plant control system interface
- Sonic Intelligence differentiates between true echoes emanating from the target material and false echoes stemming from obstructions or caused by electrical noise

Carrot juice and other foaming liquids

The capture of all operational data relating to fill quantity, level and pressure is necessary to secure consistent product quality and to monitor production efficiency. Carrot juice, when added to other liquids, tends to foam excessively during storage tank filling. High process temperatures make it difficult to reliably monitor the filling level and product volume using conventional level measuring principles.

SITRANS LR200 and LR250 radar technology

- Radar is virtually unaffected by process conditions such as foam, steam, temperature and dust
- Process intelligence for advanced echo processing for unparalleled performance
- Compact and easy-to-install transmitters





Juice

Non-concentrate orange juice is growing in popularity, creating a need for worldwide shipping of fresh orange juice. This presents technical challenges. Ships are fitted with highgrade steel tanks. The juice must be kept at a defined low temperature and the tank must be germ-free and air-tight. This is achieved by vectoring nitrogen. Both the temperature and the nitrogen pressure must be measured precisely, monitored continuously and regulated.

SITRANS LR radar level transmitter

- Uses Frequency Modulated Continuous Wave (FMCW) technology to provide high accuracy
- Easy installation and commissioning, low maintenance
- Self-calibration with internal reference
- Built-in diagnostics
- Auto False Echo Suppression and advanced echo processing
- Communications using HART® or PROFIBUS PA

Food Grade Oils

When it comes to the production of spaghetti sauce or any number of other foodstuffs that contain edible oils such as olive oil, canola oil or sunflower oil, Siemens ultrasonics are top performers. Food oils have very low dielectric constants and can render radar and guided wave radar unreliable. Ultrasonic devices work on a change in density. Dielectric of the medium being measured has no effect on the ultrasonic measurement. Ultrasonics are perfect for outdoor storage tanks for monitoring just-in-time delivery. They are equally effective for the monitoring of indoor process vessels /hoppers or day tanks. If the application requires a simple-level measurement or complete control including relays and advanced communications to be integrated to a PLC, Siemens ultrasonics have you covered.

SITRANS ultrasonic level devices

- Use high frequency ultrasonic transducers for reliable measurement performance
- Supplied standard with Sonic Intelligence for top performance in all process conditions
- Built-in diagnostics
- Auto false-echo suppression
- Communications options using PROFIBUS, HART, AB RIO, and DeviceNet



Whisky distilling

Quality ingredients and careful process monitoring are vital to the art and science of whisky production. Prior to distillation, wort (a mix of barley and water) is cooled and pumped into pear-shaped fermenting vessels (wash stills). Operators then add yeast and the mixture produces wash (weak spirit). Foam is produced which can result in boiling high levels of froth mixing with the 'low wines' from the first stages of distillation. To control the foam, the burners must be turned off and restarted as the foam dissipates. It is desirable to automate the wash still operation to control the foam. However, because foam is neither liquid nor air, it is impossible to detect with traditional level measurement devices such as floats or vibrating forks.

Pointek CLS200

- Enables foam detection as well as automatic burner turn-off and restart
- Accurate, reliable and repeatable level detection
- Uses a unique inverse-frequency approach to capacitance technology, unlike traditional capacitance devices. Pointek switches monitor the effect of capacitance by frequency change rather than voltage drop or current flow
- The result is better accuracy and resolution because even small level changes create large shifts in frequency
- Contains a high-frequency oscillator with the sensor encapsulated in the probe tip. The probe is unaffected by the build-up of material, humidity or moisture

Product purity

Many food and beverage products are created from highly bio-dynamic ingredients and processes. Quality and purity is essential. Irrespective of the type of ingredients used, food safety is a paramount consideration for food producers and Siemens alike.

SITRANS LR technology

- Tested and certified by the Institute of Food Process Engineering at the University of Karlsruhe
- The microwave emissions have been shown to have no general thermal or physical influences on liquid or dry solid foodstuffs
- A maximum transmitting power of 0.32 W/cm² ensures no effect on organisms in liquids such as beer and milk

Flow

Storage, pumping, and dosing. All three activities lie at the heart of food and beverage production and require highly accurate flow measurement. Whether it is a strawberry ingredient added to yoghurt or the syrup, or carbon dioxide injected into water for a soft drink, flow measurement is vital to quality assurance and product consistency. It is also essential to ensure compliance with environmental regulations, food safety and, in the case of alcohol, fiscal regulatory requirements.



Sugar

The first stage of processing the raw sugar is to soften the cane by removing the unrefined liquor surrounding the crystals. The raw sugar is then mixed with warm and concentrated high-purity syrup to prevent the crystals from dissolving. To optimize the extraction of crystallized sugar, the flow of liquor needs to be accurately measured at various points in the process.

SITRANS FUS1010 clamp-on flow meter

- Dual mode allows for transit time and Doppler operation at the same time on the same pipe
- External transducers are easily mounted to the outside of the pipe, there is no contact with the medium
- Accuracy up to $\pm 0.5\%$ of flow rate

Tomato Paste

When making tomato paste, raw tomatoes are first turned into pulp, which is then concentrated to a paste in an open steel vessel / steam kettle. Lastly, the preservatives are added and the paste is packed and stored. Flow meters are used to measure both the input to the kettle and the output of the thickened paste.

SITRANS FUS1010 clamp-on flow meter

- Minimal maintenance; external transducers do not require periodic cleaning
- No moving parts to foul or wear
- No pressure drop or energy loss

Dressing

Dressings may contain very salty and spicy ingredients with significant corrosive properties. As a non-sour product, dressings also provide an ideal culture medium for germs. Flow meters have direct contact with the product and it is therefore critical that coating and inliner materials are resistant to corrosion and comply with the most stringent hygiene standards.

SITRANS F M MAG 1100 F

- Magnetic-inductive flow technology and flexible communication (HART®, PROFIBUS, MODBUS, DeviceNet, FOUNDATION Fieldbus)
- Ceramic (Al_2O_3) or PFA liners
- Maximum measuring error $\pm 0.2\% \pm 1 \text{ mm/s}$
- Degree of protection (enclosure) IP67 (IP68)

Milk

Many dairy plants pour the treated milk in tin containers. These containers must be coated to prevent the milk from interacting with the tin. Health and safety considerations govern how much coating is used. The SITRANS F C is able to measure and control the coating process so that the exact quantity and thickness is applied.

SITRANS F C

- Digital input for dosing control, remote zero adjust or forced output mode
- High front-end resolution improves zero point stability and enhances dynamic turn-down on flow and density
- Fully stainless steel sensor enclosure
- EHEDG-approved programme available from DN 15–DN 80



Hygiene

Cleaning-In-Place (CIP) and Sanitization-In-Place (SIP) are central to milk processing. The flow meters must ensure that the cleaning agents are accurately dosed, the circulating velocity is correct and the system is completely empty. The process conditions – temperature, velocity and used cleaning agents – fluctuate quickly, making long-term stability and high measurement accuracy essential.

SITRANS F M

- Sanitary design for SIP/CIP cleaning
- Hygienic connections
- 3 A-approved and EHEDG-certified construction
- Stainless steel enclosure

Soft drinks

The production of soft drinks revolves around mixing. Typically, four to five components are mixed. Measuring quantity on its own is not accurate enough. The measurement must also be performed inline. The process demands a momentary accuracy of 0.1 %.

SITRANS F C

- Large dynamic turn-down ratio better than 500:1
- Densitometer performance typically better than 0.0005 g/cm^3 with repeatability better than 0.0001 g/cm^3
- Brix measurement

Brewery

A field test of the SITRANS FC 430 to quantify the concentration of sugar in unfermented beer was conducted with an international beverage manufacturer. Over the course of eight months, the meter demonstrated stability in fluctuating conditions and reliability in long-running scenarios. It also produced highly accurate readings in both stable and dynamic flow.

SITRANS FC430

- The market's most compact Coriolis solution
- Provides flow density and temperature readings accurately, reliably and with fast response times
- Complies with all major industry standards including 3 A, EHEDG, FDA
- Self-draining installation for optimum hygiene and food safety. Suitable for CIP/SIP cleaning
- High-speed 100 Hz signal processing means reliability even under dynamic conditions
- HART® communication
- Multiconfigurably I/O with up to 4 outputs

Pressure, temperature and valve positioning

Pressure measurement plays a vital role in food production plants. Besides measuring pressure for process-control purposes or for safety reasons, pressure-measuring instruments can be used to measure flow (orifice plate), level (hydrostatics) and differential pressure (filtration and heating processes) to determine parameters such as the extract content. Temperature is one of the most important parameters of all in the food-manufacturing process – both from a safety viewpoint and for process control and quality. Food safety methodologies, such as Hazard Analysis Critical Control Points (HACCP), highlight the importance not just of accurate temperature measurement but also its data capture. Valve positioners play an important role in the storage, pumping and mixing of liquids for food and beverage production. A valve positioner enables the precise control of a valve, providing the added benefit of a diagnostic capability.

Sugar

The extraction of sugar from cane or beet is a key stage in sugar production. The extraction is performed in two steps. First, the beet or cane is cut so that the sucrose can be removed in an extraction tower. Temperature control is critical. There is an optimal relationship between temperature and the energy needed to obtain the best yield of extracted sugar.

SITRANS T resistance thermometer

- Communication (4...20 mA, HART®, PROFIBUS, FOUNDATION Fieldbus) and maintenance functions enable optimization of the maintenance circle
- Hygienic design complies with EHEDG recommendations
- High-accuracy temperature measurement without disturbance of the process – clamp-on

Milk

Hygiene is a top priority in dairies. Measurement devices must satisfy high standards and be compatible with SIP and CIP processes.

SITRANS P Compact

- A pressure transmitter that has been specially designed to suit the requirements of the food and beverage industry
- Offers an optimal relationship between price and performance
- Stainless steel housing and measuring cell is flush with the tank or pipe wall making it easy to clean and sterilize
- Suitable for process temperatures of up to 200°C (392°F)
- Available with the full range of hygiene connections

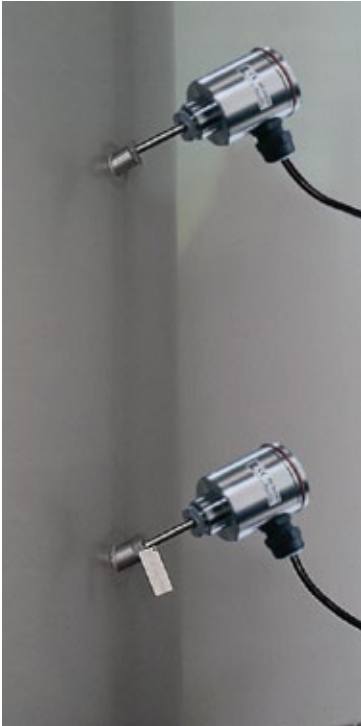

Brewery

In the fermentation process wort becomes beer, but a lot of heat is produced with temperatures of up to 70°C (158°F). Before the beer is poured into bottles, cans or kegs it must be stabilized. Both stabilization and fermentation are achieved in a number of large tanks. Level measurement is important and the most common approach is hydrostatic measurement with an accuracy of up to 6 mm in 12 m (36 ft) tanks.

SITRANS P300

- A digital pressure transmitter offering 'three push button' handling and extensive diagnostics as well as simulation functions
- The stainless steel housing and measuring cell is designed according to hygienic requirements
- Suitable for CIP and SIP processes
- Broad range of communication (HART®, PROFIBUS, FOUNDATION Fieldbus) options
- Exact and stable measurements over a long period, e.g. the deviation in measured value is less than 0.075% with a long-term stability up to 0.125% over five years

Fermentation

Valves control the filling and draining of fermentation vessels in breweries. The fermentation process can last several days. The Siemens SIPART PS2 positioner provides precise valve monitoring and diagnosis of events even before problems arise.

SIPART PS2 valve positioner

- Compatible with both rotary and linear actuators, enabling standardization on one device, saving costs on training and spare parts
- Requires very little system energy, providing a rapid return on investment
- Considerable cost savings and control optimization thanks to air consumption, advanced diagnostics that pinpoint sediment in pipes and abrasion of valve seat / cones, and automated fast and easy commissioning



Weighing and dosing

Weighing, blending and dosing are of significant importance to the food and beverage industry. The filling process and the packaging of food products require highly accurate and automated systems to ensure compliance with the strict quality and hygiene regulations of a very competitive market.

Raw materials handling and blending

Maintaining accurate inventory is required to control costs. To track inventory accurately, the customer measures the grain as it is put into storage silos. Certain mills often blend various wheat varieties to produce branded products. Continuous flow metering with SITRANS WF100 series flowmeters, along with Siemens Milltronics SF500 flowmeter integrators, improves quality and reduces process inefficiencies such as material costs and time loss.

SITRANS WF100 series flowmeter

- High accuracy for monitoring a wide range of grain product ingredients and animal-feed blending
- Compact, reliable solution for applications with limited installation space
- Stainless steel option meets USDA and FDA requirements for food processing

Malt dosing

The demands in a process such as malt dosing are immense, particularly where continuous dosage is the norm. For example, for 50 kg (110 lb) of malt at a daily capacity of 200 tons (197 LT) and 450 batches per hour, metering precision needs to be less than 10 g (0.3 oz) and batch error below 20 g (0.6 oz).

SIWAREX weighing system

- Ideal for integration into automation solutions because no additional interfacing modules are required and the same engineering tools can be used
- The module response (e. g. diagnostic messages) is system-compatible
- An event recorder with time stamp records the course and status of weighing: a crucial tool for plant optimization
- Load cells and cables are permanently monitored for predictive maintenance to prevent downtime
- Snap-on methodologies make installation very easy
- Can be totally integrated into the SIMATIC PCS 7 control system, thus providing a complete automation solution



Liquid analytics

During every step of beverage production quality control analytics are essential. Dissolved gases analysis is important for the quality of the end product, as are specific analytics such as turbidity in beer and brix in soft drinks. Effective analytics also aid optimization of operation costs, for example in monitoring CIP processes using pH and conductivity.



Brewery

Brewers know the dissolved gas levels of their products can affect both shelf stability and consumer appeal. Oxygen levels are closely controlled at low levels to assure they deliver fresh tasting and shelf-stable products. Carbon dioxide concentrations are kept within well-defined limits, so product appearance and mouth feel are consistent.

In nitrogenated products, nitrogen and carbon dioxide values are monitored to give the products the correct balance of gases to deliver a smooth, creamy head.

The Hach Lange portfolio of highly accurate dissolved gas analyzers gives brewers confidence that they are delivering the highest-quality product possible.

Orbisphere M1100 O₂ LDO

- Luminescent Dissolved Oxygen for process measurements in the ppb range, with low drift, fast response time and low maintenance

Orbisphere A1100 O₂

- Robust and accurate electro-chemical sensor for gas-phase measurement in the CO₂ recovery systems or for monitoring high O₂ levels during fermentation

Orbisphere 314xx CO₂/315xx N₂

- Selective sensors for CO₂ or N₂ measurement in a continuous mode, needing only an annual maintenance and calibration

An important step in the production of beer is the filtering which is determinant for the quality.

Züllig Cosmos XL

- This turbidity sensor can be installed directly in the pipe, making the set-up easy and cost-effective. The sensor has been designed to be cleaned easily and to be scratch-resistant

Process Instrumentation and Analytics product range

Siemens offers the most comprehensive product range for the food & beverage industry and has a solution for even the most difficult measurements.





Continuous level measurement





Radar

| | | |
|--|---|---|
|  |  |  |
| <p>Liquids level measurement</p> | <p>Solids level measurement</p> | <p>SITRANS LG200</p> |
| <p>SITRANS LR200 and SITRANS LR250 offer continuous monitoring of liquids and slurries in storage / process vessels. SITRANS LR250 is available with fully resistive PVDF antenna design for use in sanitary environments.</p> | <p>SITRANS LR260 and SITRANS LR560 offer continuous monitoring of solids in a variety of silos or storage bins.</p> | <p>2-wire, guided wave radar transmitter for short- to medium-range level, level / interface, and volume measurement of liquids and solids.</p> |

Flow measurement

| | | |
|---|--|---|
|  |  |  |
| <p>Electromagnetic flowmeters</p> | <p>Coriolis flowmeters</p> | <p>Clamp-on ultrasonic flowmeters</p> |
| <p>Siemens full series of flowmeters for liquids and slurries gives a wide range of customer-specified process connections.</p> | <p>One of the most accurate flow measurement technologies, measuring true mass flow unaffected by variations in pressure, temperature, density, electrical conductivity and viscosity. It is a multi-variable device delivering reliable information on mass flow, volume flow, temperature, density and concentration (e.g. Brix or Baume). SITRANS FC430 is the market's most compact Coriolis solution. The small size facilitates installation and replacement, and makes it possible to fit multiple units into tight spaces.</p> | <p>The key feature of the clamp-on ultrasonic flow technology is the externally-mounted sensor. They are quickly and easily installed on the outside of the pipe. The technology provides highly accurate measurement on pipes with different sizes, making them suitable for a wide range of applications.</p> |

| | |  Point level | |
|---|--|--|--|
| Ultrasonic | | | |
|  | |  | |
| SITRANS Probe LU | | Level controllers and transducers | |
| <p>2-wire, loop-powered ultrasonic transmitter for level, volume and flow monitoring of liquids in storage vessels, simple process vessels and open channels.</p> | | <p>SITRANS LUT400 can be used in a variety of applications in combination with Echomax transducers.</p> | |
| | |  | |
| | | Point level switches | |
| | | <p>SITRANS LPS200, SITRANS LVS200, Pointek CLS200, SITRANS LVL200 and Pointek ULS200 offer a range of level detection options for liquids and solids applications.</p> | |

|  Pressure |  Temperature |  Positioning |
|---|--|--|
|  | | |
| Pressure measurement | SITRANS T | SIPART PS2 |
| <p>SITRANS P offers a complete range of instruments for measuring relative, differential and absolute pressure. The SITRANS P300 has a hygienic stainless steel housing with laser-etched nameplate. The SITRANS P300 meets the requirements of EHEDG, FDA and 3 A. Cleaning and sterilization are standard practice.</p> | <p>The clamp-on thermometer offers quick and highly accurate measurement without disturbance of the process and provides easy recalibration. Equipped with our unique SITRANS TH or TR transmitters, we offer the turnkey solution. Classical wetted temperature sensors complete the temperature measurement portfolio.</p> | <p>Positioner for linear and rotary actuators. Particularly flexible stroke range, intelligent diagnostics and communication either via HART, PROFIBUS PA or Foundation Fieldbus</p> |

 Weighing

| | | | |
|---|--|---|--|
|  |  |  |  |
| <p>SITRANS solids flowmeters</p> | <p>Milltronics belt scales</p> | <p>SITRANS weighfeeders</p> | <p>SIWAREX PLC-based weighing systems</p> |
| <p>Accurate measurement and control of flow rates of product so that quality and plant efficiency are consistently maintained. Dust-tight, ensuring a healthier work environment, especially during hazardous substance monitoring.</p> | <p>Heavy-duty, High-accuracy single idler belt scales used for process and load-out control. Milltronics belt scales provide continuous inline weighing for monitoring such products as flour, grain or sugar.</p> | <p>Control and monitor feed rates and blending in cereals, seeds or minerals; easy belt removal for replacement or cleaning, fast installation, easy to clean and maintain.</p> | <p>Provide optimum integration into the automation structure of the process. Ideal for users familiar with the SIMATIC PCS 7 process control</p> |

 Process protection

 Liquid analytics

| | | | |
|---|--|---|---|
|  |  |  |  |
| <p>Motion sensors</p> | <p>Acoustic monitoring</p> | <p>Orbisphere M1100 O₂ LDO</p> | <p>Orbisphere A1100 O₂</p> |
| <p>Most MFA 4p motion sensing probes as well as the Millpulse 600 can be mounted up to 100 mm (4") from the ferrous target, reducing the chance of damage to the probe and the equipment. SITRANS WM100 zero-speed alarm switch provides equipment protection</p> | <p>SITRANS AS100 detects changes in high-frequency sound waves resulting from particle impacts on equipment. In combination with SITRANS CU02 alarm control unit, it detects and reacts instantly to changes in solids flow.</p> | <p>Specifically designed for brewery applications, this sensor uses luminescent measurement technology to monitor very low oxygen levels with a quick response time, offering 'peace of mind' and cost benefits to every quality control manager.</p> | <p>This electro-chemical oxygen sensor measuring in liquid or gas phase from ppb level to saturation is the reference on the market in terms of accuracy and longevity.</p> |

| | | | Remote monitoring and displays |
|---|--|--|--------------------------------|
|  |  |  | |
| Speed sensors | Weighing integrators | Remote displays | |
| Speed sensors operate in conjunction with a conveyor belt scale, providing a signal to an integrator (Milltronics BW100 or BW500, or SIWAREX FTC module), which computes the rate of material being conveyed. | Milltronics BW500 and BW500/L integrators work with single or dual strain gauge load cell-based belt scales. Milltronics SF500 operates with any solids flowmeter with up to two strain-gauge load cells or LVDT sensor. | SITRANS RD100/200 are remote displays for process instrumentation. SITRANS RD500 provides integrated web access, alarm event handling, and data capture. | |

| | | | Process Analytics |
|---|--|--|-------------------|
|  |  |  | |
| Orbisphere 314xx CO ₂ / 315xx N ₂ | Orbisphere 410/510 controller | Continuous gas analyzer | |
| Thermal conductivity sensors measuring carbon dioxide or nitrogen in dissolved mode or gas phase, directly inline with a short response for a quick reaction to process change. | The Orbisphere sensors are connected via easy-to-use colour touchscreens. The stainless steel enclosure conforming to IP65 defines a robust unit built to handle industrial environments. Traditional analogue outputs with 3 alarm relays and the digital communication via RS485, USB and Profibus provide multiple data exchange. | The ULTRAMAT 23 is a continuous gas analyzer designed for emission monitoring applications. The integrated automatic calibration function using ambient air is a unique advantage. | |

Totally Integrated Automation

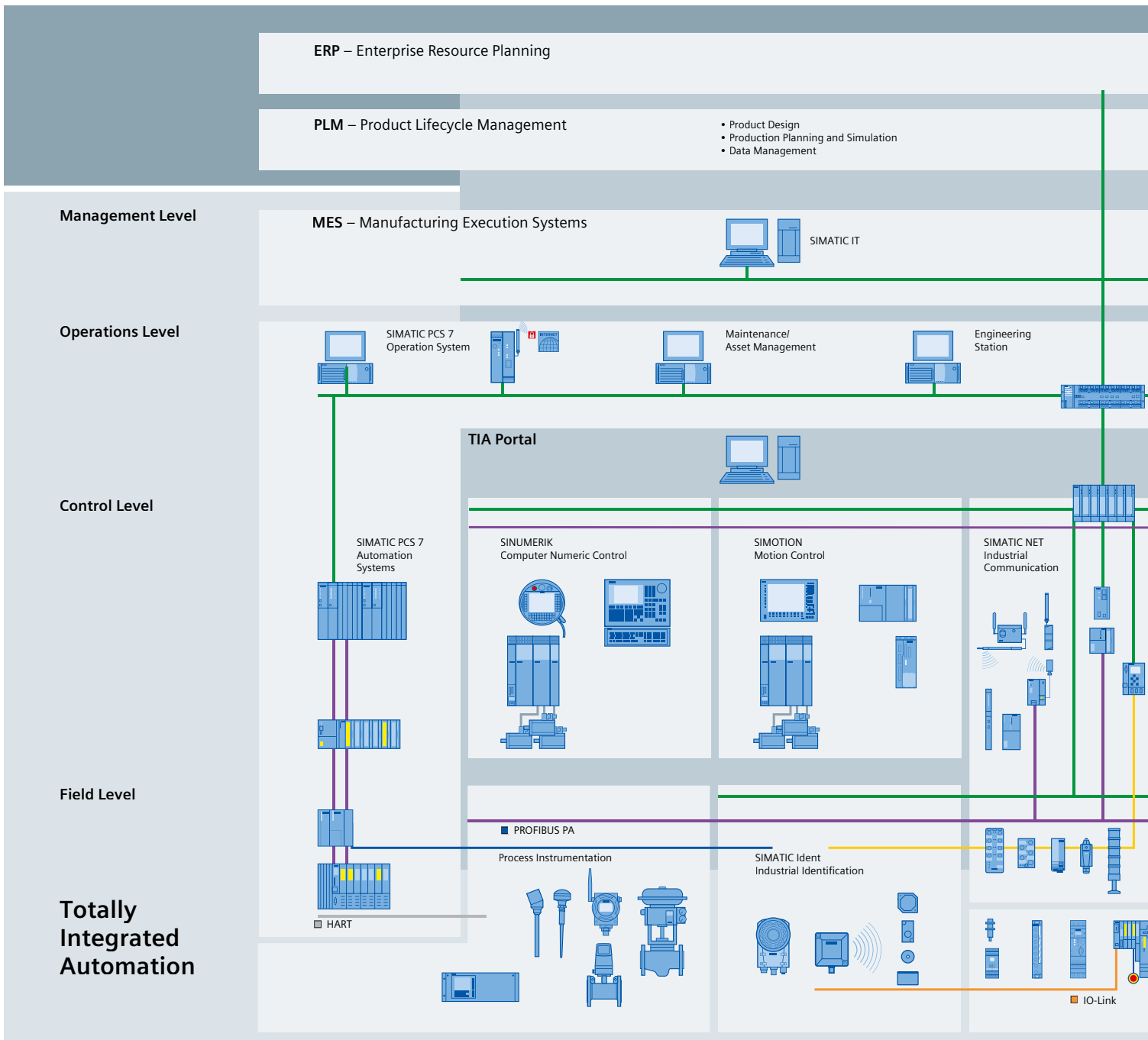

Products from the controller level to the field level

With Totally Integrated Automation (TIA), Siemens is the only provider of an end-to-end integrated portfolio of products and systems for the automation of the entire production workflow. From the goods receiving area to the finished goods warehouse.

Totally Integrated Automation reduces the complexity of the automation solution and enables what really counts: the practical combination of optimally coordinated individual components – without interface problems.

Totally Integrated Automation integrates not only the production process but all parts of the company – from the field level to the management level. The result: a perfectly coordinated overall concept that enables higher productivity.

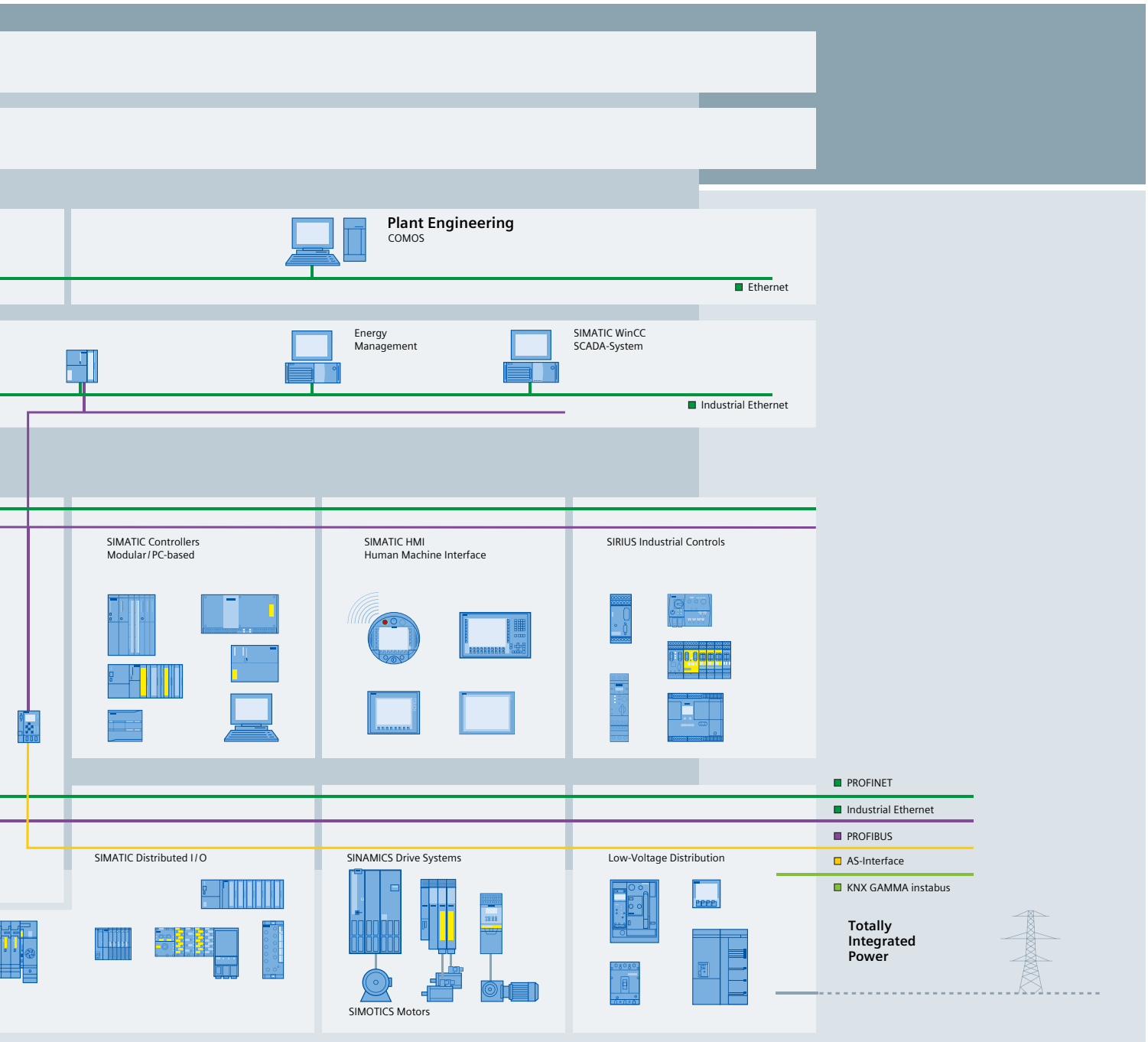

Example: SIMATIC PCS 7. The innovative process control system offers numerous options for connecting I/Os as well as for sending and receiving process signals via sensors and actuators.

Industrial Identification

Identification systems assist companies in keeping their positions in ever more dynamic markets: Automatic data acquisition via RFID or 1D and 2D codes will help you meet the continuously growing demands made on control of production and material flows, asset management, tracking & tracing as well as supply chain management. Siemens provides the key technology for this purpose. As the global market leader for identification systems with more than 25 years of experience and industry expertise in the field, Siemens offers a comprehensive range of RFID systems and code reading systems from one supplier.

Radio Frequency Identification and Code Reading Systems

The right solution for every identification job from just-in-sequence production to safe and complete traceability of products or batches: Data Matrix Codes (DMC) or Radio Frequency Identification (RFID) convince through their high level of data security and have proven themselves in many applications – even in rough industrial environments. They offer a serious reduction in time and effort when compared to manual identification and acquisition techniques.

SIMATIC Ident: industrial identification from a single source

- Broad range of identification systems (RFID, 1D/2D code-reading systems, OCR), interface modules and software
- Fully automatic and high-speed identification, with 100% transmission reliability
- Components with a high degree of protection for industrial use, insensitive to temperature fluctuations and contamination
- Wide range of tags – from smart labels to 64 KB transponders
- Flexible communication with the automation system: serial, via PROFIBUS, PROFINET or Ethernet
- High-performance integration into higher-level IT systems

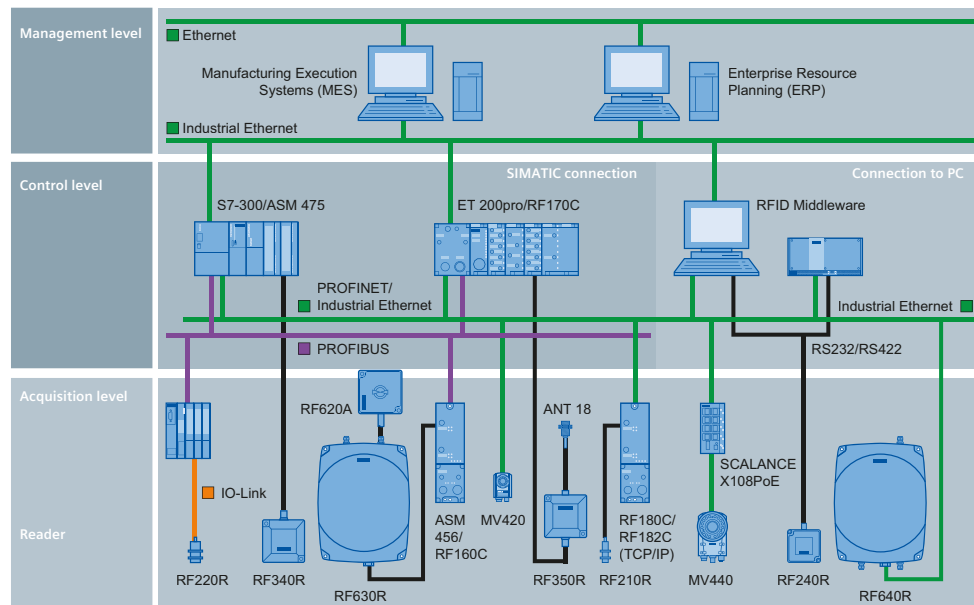

Services and support

Siemens offers field-proven concepts for process instrumentation and analytics from a single source, providing you with development continuity and a high level of security.



Our services range from consulting and engineering, connection to the control system and comprehensive after-sales services:

- System and schedule planning
- Complete design planning and engineering of the field devices
- Consultation on the selection of process instruments and analytics
- System documentation
- Installation, testing and commissioning
- Comprehensive after-sales service

Service around the world

Plants must function reliably around the clock. Efficient and effective process instrumentation and analytics are an indispensable prerequisite to this end. You also need to be certain of fast and competent service from your supplier. Siemens is a global company that reacts locally. Whether you require consulting, quick delivery or installation of new devices, the Siemens network of specialists is available to you around the world, whatever your location.

Service around the clock

Our online support system offers rapid, comprehensive assistance regardless of time or location. From product support to service information, the online support of Siemens Industry Automation and Drive Technologies is your first choice – around the clock, 365 days a year.

www.siemens.com/automation/service&support

More information:
www.siemens.com/sensors/food-beverage

Siemens AG
Industry Sector
Sensors and Communication
76181 KARLSRUHE
GERMANY

Subject to change without prior notice 06/12
Order No.: E20001-A180-P780-X-7600
DISPO 27900
o2e MI.SC.IM.XXXX.52.2.05
WS 06123.0
Printed in Germany
© Siemens AG 2012

The information provided in this brochure contains merely general descriptions or characteristics of performance which in case of actual use do not always apply as described or which may change as a result of further development of the products. An obligation to provide the respective characteristics shall only exist if expressly agreed in the terms of contract.

All product designations may be trademarks or product names of Siemens AG or supplier companies whose use by third parties for their own purposes could violate the rights of the owners.